

## VCL-F4D2H-WX



### Features

- ◆ 1/3 type Panasonic **CMOS**
- ◆ f=3.6mm Fixed Lens
- ◆ **AHD 2.0 (1080P@30fps)**
- ◆ CVBS(High Resolution of 850 TVL
- ◆ Slow Shutter control (Sens-Up)
- ◆ **Enhanced 2D/3D-NR**
- ◆ DEFOG / HLC / BLC / D-WDR
- ◆ FRC (Frame Rate Control)
- ◆ **UTC(Coaxial Cable(Pelco-C))**
- ◆ Waterproof(IP67)

### Specification

Camera	Image Device	1/3 type Panasonic CMOS
	Scanning System	Progressive Scan
	Total Pixels	1956(H) x1266(V) : 2.48Mega pixels
	Effective Pixels	1944(H) x 1092(V) : 2.12Mega pixels
	Lens	Board
	Min. Illumination	0.1Lux@F2.0 , 30IRE
	Sync System	Internal
	Electronic Shutter	NTSC : 1/30~1/50,000sec(X2~X30), PAL : 1/25~1/50,000sec (X2~X30)
Video	Output	AHD (NTSC, PAL) or CVBS(960H, NTSC, PAL)
	Resolution& frame rate	1080@30p/25p
OSD	Language	English, Korean, Japanese, Chinese, Russian, French, Spanish, Italian, Portuguese, Dutch, German, Polish, Turkish, Hebrew, Arabic
	LENS	DC/ MANUAL
	EXPOSURE	SHUTTER/ AGC/ SENS-UP(max. x30)/ BRIGHTNESS/ D-WDR/ DEFOG
	BACK LIGHT	OFF/ BLC/ HSBLC
	WHITE BALANCE	AWB/ATW/ PUSH LOCK/ INDOOR/ OUTDOOR/ MANUAL
	DAY&NIGHT	AUTO/ COLOR/ B&W/ EXTERN
	2/ 3DNR	OFF/ LOW/ MIDDLE/ HIGH
	SPECIAL	CAM TITLE/ D-EFFECT/ MOTION/ PRIVACY/ LANGUAGE DEFECT/ RS485
	ADJUST	SHARPNESS/ MONITOR/ LSC/ VIDEO.OUT
	Others	Operating Temperature
Storage Temperature		-4°F~140°F (-20°C~+60°C)
Humidity		Less than 80%
Power Consumption		DC12V(±10%), Max.100mA

### Dimension

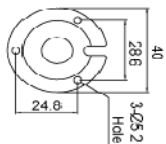
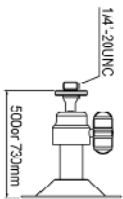
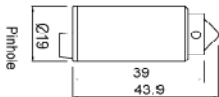
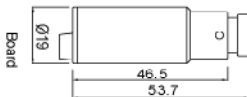
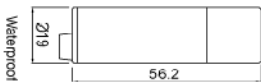

### Option



Lens

# VCL-F4D2H-WX

## Interface

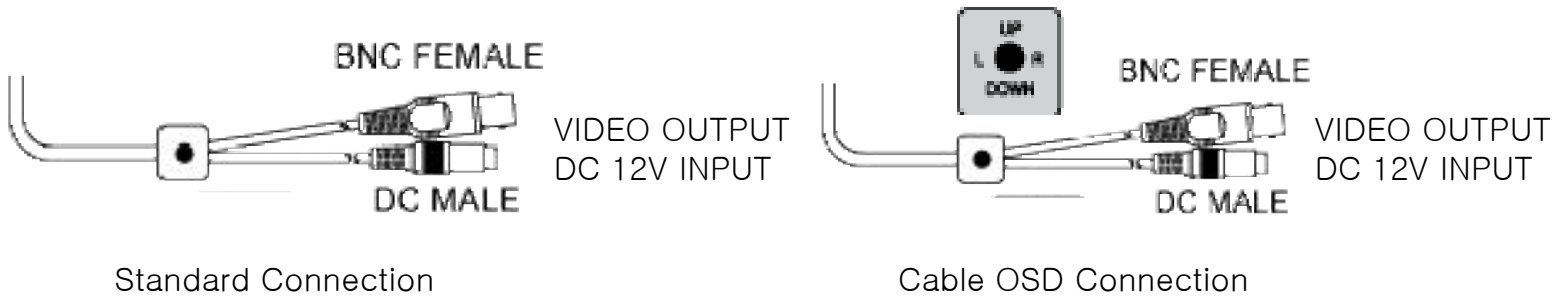

Standard Connection

Cable OSD Connection

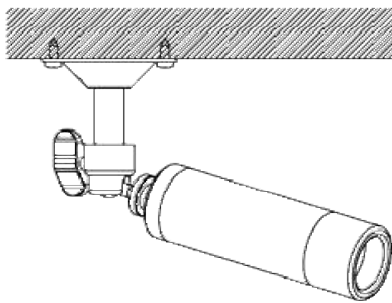

(unit : mm)

